

EFL1803-HV-9

HIGH CAPACITY ELECTRIC COUNTERBALANCED FORKLIFT 18T

 18000 kg  8000 mm  618.24 V Li-Ion



The EFL1603/1803HV Series is built for large-scale industries such as steel production, mining, ports, and construction material handling. With lifting heights of up to 7,000 mm and powerful traction performance, it enables efficient movement of heavy loads over long shifts. Thanks to its pneumatic tires, robust IC-style chassis, and hydraulic steering, it performs equally well on uneven outdoor terrain. Optional equipment—such as sideshift fork positioners, full cabins with AC, and telematics integration—makes it adaptable to a variety of specialized logistics applications.

SPECIFICATION	REF	UNIT	VALUE
Battery type			Li-Ion
Battery nominal capacity K5		Ah	618.24/228
Battery voltage		V	618.24
Rated capacity	Q	kg	18000
Load centre distance	c	mm	900
Service weight		kg	24100
Height, mast lowered	h ₁	mm	3700
Lift	h ₃	mm	4000
Height, mast extended	h ₄	mm	5660
Overall length		mm	7370
Overall width	b ₁ /b ₂	mm	2530
Length to face of forks	l ₂	mm	5550
Fork dimensions	s/e/l	mm	100×250×1800
Turning radius		Wa	5175
Manufacturer			EP
Model designation			EFL1803-HV-9

Features

High Performance: High speed and high gradeability

High-voltage Li-ion batteries enable more power delivery to motors, improving acceleration and travel speeds for high-capacity trucks. PMSMs complement this with rapid response times, swiftly reaching required speeds and torques. This combination of PMSM and high voltage can provide stable and strong power output, which further gives high-capacity trucks excellent climbing capabilities ensuring that the forklift can cope with various applications with ease.

The high-voltage model offers a 1.5-2 times performance improvement over the low-voltage model. Taking the 10-ton model as an example:

100% improvement in travel speed for high voltage models in laden and unladen conditions.

The high-voltage model demonstrates a 45% faster lifting speed.

100% improvement in gradeability when unladen, 45% improvement when laden for high voltage models.

Energy Efficiency: extended runtime and fast charging

High-voltage Li-ion batteries have high energy density and can store more electrical energy within a compact volume. High-voltage systems consume less energy and provide longer battery running time comparing low-voltage systems. Notably, these high-voltage Li-ion batteries boast an impressive cycle life of up to 4000 cycles, ensuring long-term durability and minimizing the need for battery replacements.

The PMSMs incorporate advanced control technology to optimize motor efficiency. Unlike traditional AC motors, PMSMs have higher energy conversion efficiency and reduce energy waste. This means that high-capacity trucks can work continuously for prolonged hours at lower costs.

Equipped with fast charging capabilities, high-capacity trucks offer a remarkable charging experience. The high-voltage models are compatible with vehicle-grade charging stations and support 1C charging rating, allowing them to be fully charged in as fast as 1-1.2 hours. This minimizes downtime and maximizes productivity, making it ideal for multi-shift operations

Lithium batteries present considerably lower charging costs than fuel expenses. The integration of high-voltage and PMSM technology achieves up to 15% greater electricity savings versus traditional lithium and AC technology configurations. This significantly reduces long-term energy consumption costs.



Safety Assured: Battery, motor protection, monitoring and mast buffering

Both high-voltage lithium batteries and PMSM employ multiple protective measures to ensure safe operations including overcharge protection, over-temperature monitoring, short-circuit protection, etc. minimizing the risk of potential hazards and maximizing operational safety.

The central controlling module- VCU (Vehicle Control Unit) extends the safety of the high-voltage forklifts. VCU provides precise control and real-time monitoring of critical parameters to ensure the truck operates within safe limits.

It also features turn speed control, which adjusts the forklift's speed based on the turning angle, ensuring stability during turns. An over-speed alarm alerts the operator if the forklift exceeds the safe speed limit.*

The high-capacity forklift mast is equipped with a hydraulic buffering system that ensures smooth lifting and lowering of loads. With controlled deceleration, the fork movement is smooth with no abrupt stops that could damage the load or cause operator discomfort. This feature enhances operational safety and prolongs the lifespan of the mast components.



Smart and reliable strategy for thermal management

The high-capacity trucks utilize three distinct cooling systems to ensure optimal performance and reliability. Specifically, two water cooling systems are employed for the motor and the battery, while an oil cooling system is dedicated to the hydraulics system.

The water cooling systems provide superior cooling performance, preventing the truck from overheating even under the most demanding conditions or in the heat of summer. Water's higher heat transfer capacity compared to air allows it to dissipate heat more efficiently from critical components like the motor and battery. This efficient heat dissipation helps maintain the battery temperature around 30~35 °C , protecting these vital components from overheating and potential damage or failure. Consequently, this enhances the overall reliability and longevity of the high-capacity trucks.

Additionally, water cooling systems typically operate with less noise compared to air cooling systems that rely on high-speed fans. This noise reduction is particularly beneficial in applications where a quieter operation is desirable, such as in urban areas or indoor facilities.

The oil cooling system, on the other hand, is used for the hydraulics system. This system ensures that the hydraulic components remain within optimal temperature ranges, thereby maintaining their efficiency and preventing overheating. By effectively managing the temperature of the hydraulics system, the oil cooling system contributes to the smooth and reliable operation of the truck's hydraulic functions.

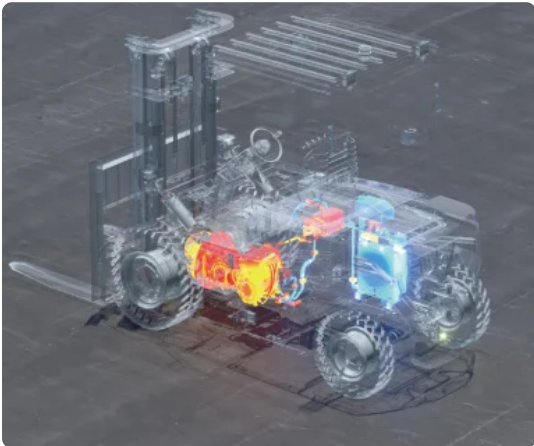

Low maintenance: Longer battery life span

Operating at a higher voltage allows the battery to be designed with fewer individual cells. With fewer components and a simpler design, the risk of battery failure is lowered.

Thanks to advanced BMS (Battery Management System) which helps to regulate and monitor high-voltage battery, these batteries tend to have a longer life than low-voltage lithium batteries, reducing the need of battery replacement.

The brushless, simple rotor design of PMSM eliminates mechanical wear from brushes and commutators. This durable, low-friction construction requires minimal periodic maintenance, reducing associated labor costs and downtime.

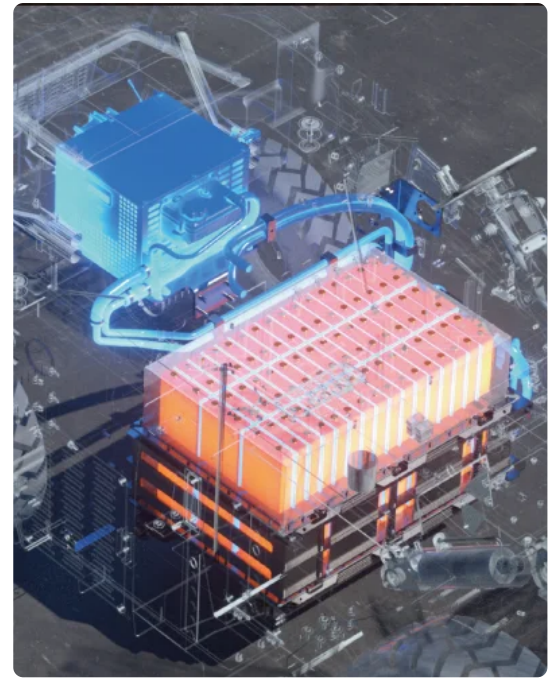

Sustainability : Zero emissions for cleaner environment

As fully electric trucks powered by lithium-ion batteries, these forklifts produce zero emissions during operation, eliminating exposure to toxic fumes like carbon monoxide and nitrogen oxides. Unlike lead-acid batteries which can leak corrosive acid, lithium-ion batteries do not risk hazardous spills. The high-capacity li-ion trucks contribute to a cleaner and safer indoor working environment without compromising handling capabilities.

Strong adaptability adaptable to harsh outdoor weather conditions

Experience uninterrupted productivity through rain, puddles, and damp conditions with the overall IPX4 rating. Plus an exceptional IP67 rating for high-voltage components. Engineered to withstand harsh temperature, high-capacity trucks offer an ambient temperature range of -20 °C ~40 °C allowing them to perform no matter climate.

Battery heating when charging comes as a standard function for high capacity models, which is activated when the surrounding temperature is below zero to always offer an optimal temperature range for efficient and safe charging even in cold weather conditions.



The dual front wheels is a standard configuration on several models offering a wider base of support, which greatly improves the forklift's stability. Considering the capacity loads of the high-capacity trucks, the weight of the load is more evenly distributed across a larger surface area. The increased ground contact area provided by the dual wheels enhances traction. This is particularly beneficial in environments where the floor may be slippery or uneven while operating outdoors, ensuring that the forklift can maintain a firm grip and operate safely. This not only helps in maintaining balance but also minimizes the stress on individual tires, extending the lifespan of the tires.

Great support for clients' investment: After-sales Service

Remote/Online Services:

Telematics technology enables remote monitoring of battery conditions, performance status, and other critical parameters for forklifts. Additionally, production, technical, and after-sales experts are available around the clock to provide prompt and comprehensive solutions for any maintenance issues through virtual support.

Physical Services:

Comprehensive manuals and supporting documents are provided for all forklift models. In case of breakdowns or replacements, spare parts are swiftly delivered to the clients' locations by global subsidiaries or domestic inventory, minimizing operational disruptions caused by equipment downtime.

VDI Chart

SPECIFICATION	REF	UNIT	VALUE
1.1	Manufacturer		EP

SPECIFICATION		REF	UNIT	VALUE
1.2	Model designation			EFL1803-HV-9
1.3	Drive			Electric
1.4	Operator type			Seated
1.5	Rated capacity	Q	kg	18000
1.6	Load centre distance	c	mm	900
1.8	Load distance, centre of drive axle to fork		mm	1030
1.9	Wheelbase		mm	3750
2.1	Service weight		kg	24100
2.2	Axle loading, laden front/rear		kg	38770/3330
2.3	Axle loading, unladen front/rear		kg	11800/12300
3.1	Tyres			Pneumatic
3.2	Tyre size, front		mm	12.00-24-24PR
3.3	Tyre size, rear		mm	12.00-24-24PR
3.5	Wheels, number front/rear (x=drive wheels)			4x/2
3.6	Tread width, front	b_{10}	mm	1880
3.7	Tread width, rear	b_{11}	mm	2200
4.0	Max lift height	H	mm	8000
4.1	Tilt of mast/fork carriage forward/backward		°	6/12
4.2	Height, mast lowered	h_1	mm	3700
4.3	Free lift		mm	110
4.4	Lift	h_3	mm	4000
4.5	Height, mast extended	h_4	mm	5660
4.7	Height of overhead guard (cabin)		mm	3220
4.8	Seat height relating to SIP/stand height		mm	2050
4.12	Coupling height		mm	430
4.19	Overall length		mm	7370
4.20	Length to face of forks	l2	mm	5550
4.21	Overall width	b_1/b_2	mm	2530
4.22	Fork dimensions	s/e/l	mm	100x250x1800
4.23	Fork carriage ISO 2328, class/type A, B			-
4.24	Fork carriage width		mm	2500
4.31	Ground clearance, laden, below mast		mm	165
4.32	Ground clearance, centre of wheelbase		mm	265
4.34.1	Aisle width for pallets 1000x1200 crossways		Ast	8145

	SPECIFICATION	REF	UNIT	VALUE
4.34.2	Aisle width for pallets 800 × 1200 crossways		Ast	8145
4.35	Turning radius		Wa	5175
5.1	Travel speed, laden/unladen		km/h	20/20
5.2	Lift speed, laden/unladen		m/s	0.35/0.4
5.3	Lowering speed, laden/unladen		m/s	0.5/0.35
5.5	Drawbar pull, laden/unladen			92000/92000
5.6	Max. drawbar pull, laden/unladen			95000/95000
5.8	Max. gradeability, laden/unladen		%	20/30
5.10	Service brake			Mechanical/Hydraulic
5.11	Parking brake			Mechanical/Hydraulic
6.1	Drive motor rating S2 60 min		kW	90
6.2	Lift motor rating at S3 15%		kW	60
6.4	Battery nominal capacity K5		Ah	618.24/228
6.4	Battery voltage		V	618.24
6.4.1	Battery type			Li-Ion
6.5	Battery weight		kg	932
6.6	Energy consumption according to DIN EN 16796		kWh/h	20.9 ¹⁾
6.7	Turnover output according to VDI 2198			/
6.8	Turnover efficiency according to VDI 2198			/
8.1	Type of drive unit			PMSM
10.1	Operating pressure for attachments		bar	180
10.2	Oil volume for attachments		ℓ/min	80
10.5	Steering design			Hydraulic
10.7	Sound pressure level at the driver's seat		dB(A)	< 75
15.1	Charger output current		A	115

EFL1603-HV-12 RATED CAPACITIES AND LOAD CENTERES GRAPH

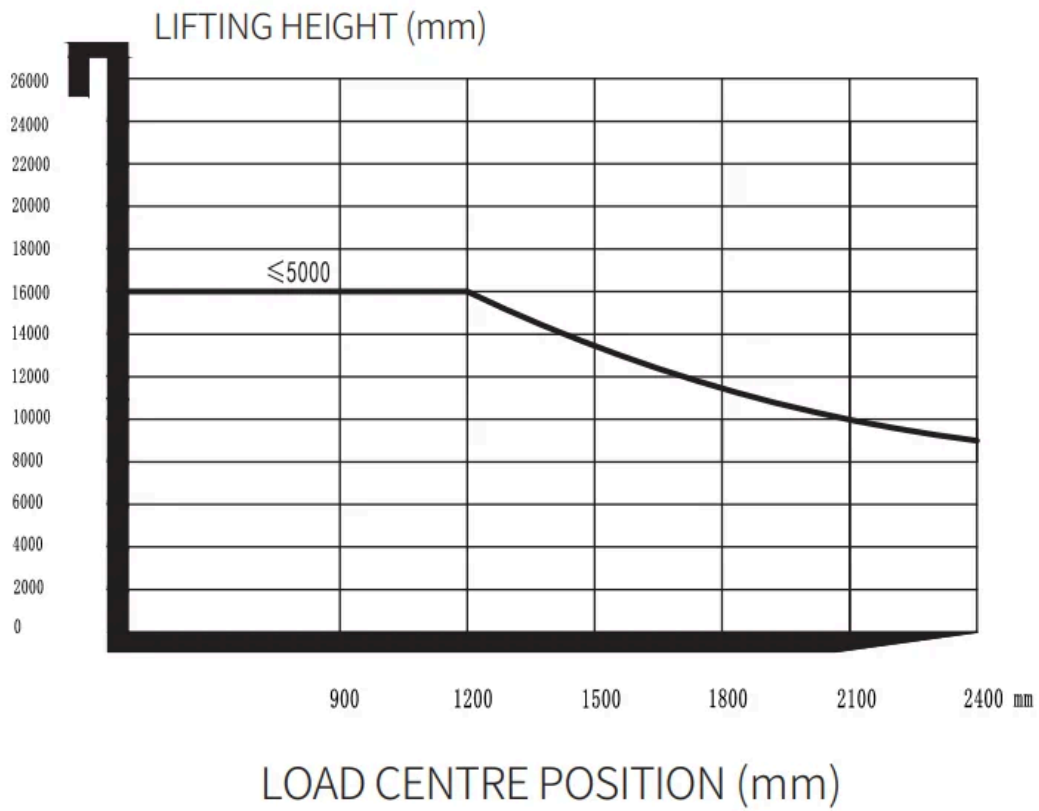

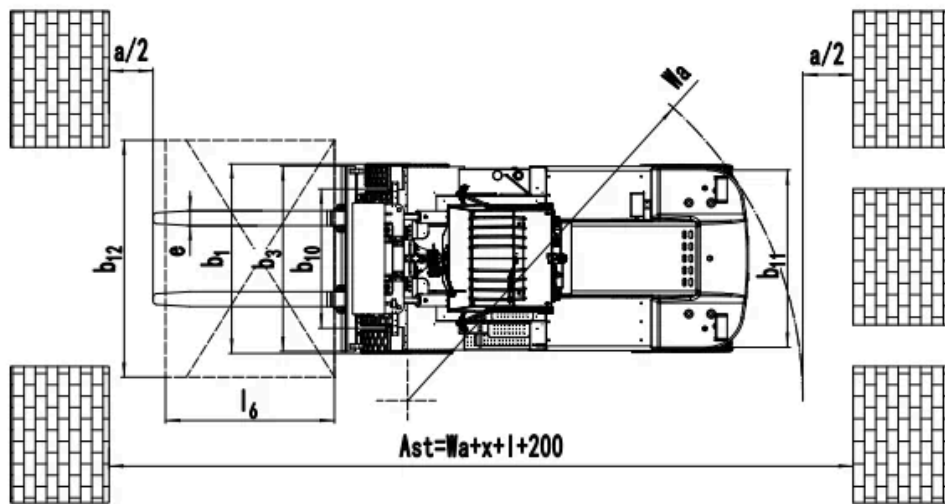
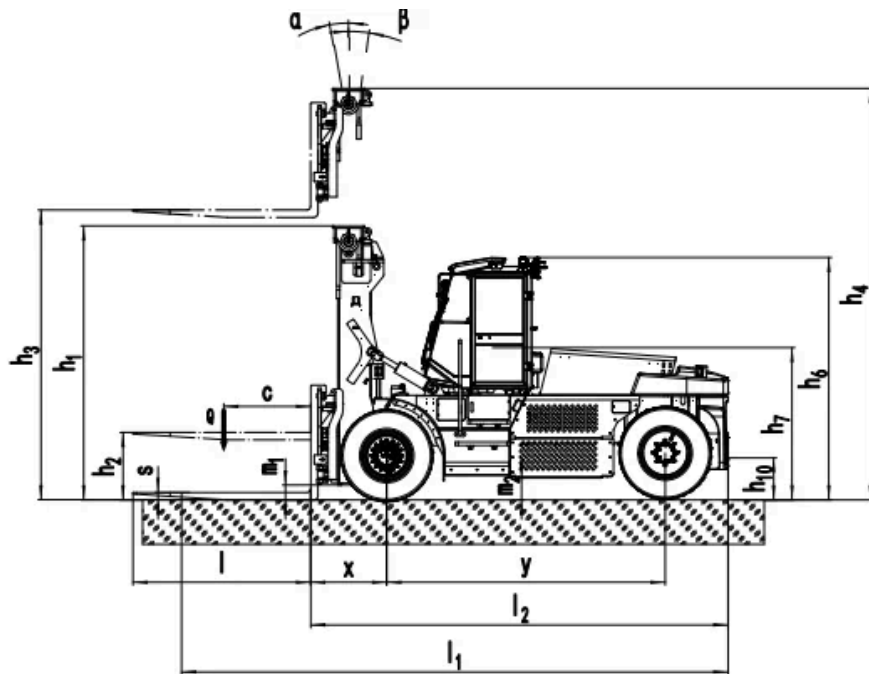

Mast Options

MAST TYPE	LIFT HEIGHT (H3, MM)	MAST LOWERED HEIGHT (H1, MM)	MAST EXTENDED HEIGHT, NO BACKREST (H4, MM)	FREE LIFT HEIGHT, NO BACKREST (H2, MM)	FORWARD TILT (A, DEG)	BACKWARD TILT (B, MM)	LOAD DISTANCE (X, KG)
2-Standard Mast	3500	3440	5140	110	6	12	1030
2-Standard Mast	4000	3700	5660	110	6	12	1030
2-Standard Mast	4200	3750	5800	110	6	12	1030
2-Standard Mast	4500	3900	6100	110	6	12	1030
2-Standard Mast	5000	4150	6600	110	6	12	1030

MAST TYPE	LIFT HEIGHT (H3, MM)	MAST LOWERED HEIGHT (H1, MM)	MAST EXTENDED HEIGHT, NO BACKREST (H4, MM)	FREE LIFT HEIGHT, NO BACKREST (H2, MM)	FORWARD TILT (A, DEG)	BACKWARD TILT (B, MM)	LOAD DISTANCE (X, KG)
3-Free Mast	4000	2963	5720	1293	6	12	1110
3-Free Mast	5000	3130	6220	1460	6	12	1110
3-Free Mast	4500	3200	6430	1530	6	12	1110
3-Free Mast	4710	3297	6720	1627	6	12	1110
3-Free Mast	5500	3463	7220	1793	3	6	1110
3-Free Mast	6000	3630	7720	1960	3	6	1110
3-Free Mast	6500	3797	8220	2127	3	6	1110
3-Free Mast	7000	3963	8720	2293	3	6	1110
3-Free Mast	7500	4130	9220	2460	3	6	1110
3-Free Mast	8000	4297	9720	2627	3	6	1110

Options

ITEM	OPTIONS (optional items marked in yellow)
Fork dimension	Customized fork length/non-standard accessories Roller guided forks 1800/2440mm forks Fork positioner with sideshift
Fork carriage width option	Customized fork carriage width 2500 fork carriage
Battery capacity	309V228Ah LFP battery 618.24V/228AhLFP battery
Charger	20kw (3 phase AC 370V-460V, 50-60HZ, 32A plug) 40kw (3 phase AC 370V-460V, 50-60HZ, 63A plug)
Seat type	Grammer 85/722 Suspension seat with armrest, heating and OPS
Attachments	Fork positioner with sideshift: Forks with terminal west Fork positioner with sideshift: Roller-guided forks
Buzzer	Yes
Camera	Reversing radar/reversing camera/reversing radar and camera
OPS system	Yes
USB interface	USB interface 24V
Telematics	Yes

ITEM	OPTIONS (optional items marked in yellow)
Cabin	All weather cabin with rubber damping frame connection, heater and air conditioner, defrost and defogging function and elector-hydraulic tilting function
Turn speed control	Yes
Heating system during lithium battery charging	Yes
Lighting package	Lighting package: LED front working light (with far and near light, steering light, width light), LED working light on mast, LED tricolor taillights, LED rear working light (with reversing light, brake light, steering light, width light), Strobe warning light Rotating warning light / rotating buzzer warning light Front blue spots on mast Rear blue spots on counterweight Area steering lights on both side (red)
Options	Fingertips Cigarette lighter socket 12V5A
Tyres type	Pneumatic Solid tyres / non-marking tyres
Mast lifting and lowering buffer	Yes
Mechanical lever	Yes
Rear grab handle with horn	Yes