

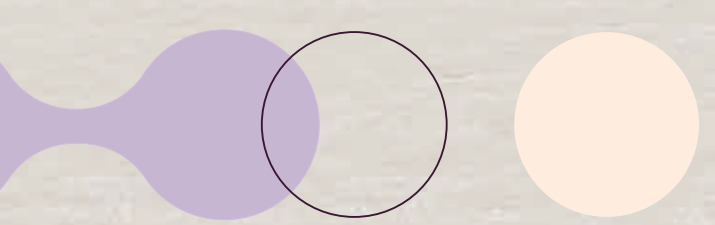

TL2 Essential Terminal Tractors

Quality for all



Kalmar Essential Range 

Built from experience

The Kalmar Essential Terminal Tractors give you everything you expect from Kalmar - a quality build with high availability and excellent productivity for a very competitive price.

Kalmar Essential Terminal Tractors have been built on the accumulated knowledge and experience of manufacturing over 80,000 terminal tractors globally. You will benefit from a robust and reliable terminal tractor that will continually perform at optimal levels

The world's leading supplier of terminal tractors

With over 80,000 terminal tractors built globally, Kalmar knows how important it is to be where you are. Our global support network are always close by and are there to support your business for the long run.



Built on a proven platform.

Our latest platform has been tested and proven in the field with over 10,000 machines already in operation.



With a bolted chassis.

The Essential Terminal Tractor has a bolted rigid chassis that can easily be repaired and maintained, it is also less likely to suffer from cracking than a traditional welded frame.



Built to last.

Kalmar only uses quality materials and parts in all its machines, which gives you a highly reliable machine that will take less time and effort to maintain and service.



Built to save money.

With up to a 15% reduction in fuel consumption due to smart programming and longer maintenance intervals - you will benefit from lower fuel costs, carbon emissions and higher levels of machine availability.

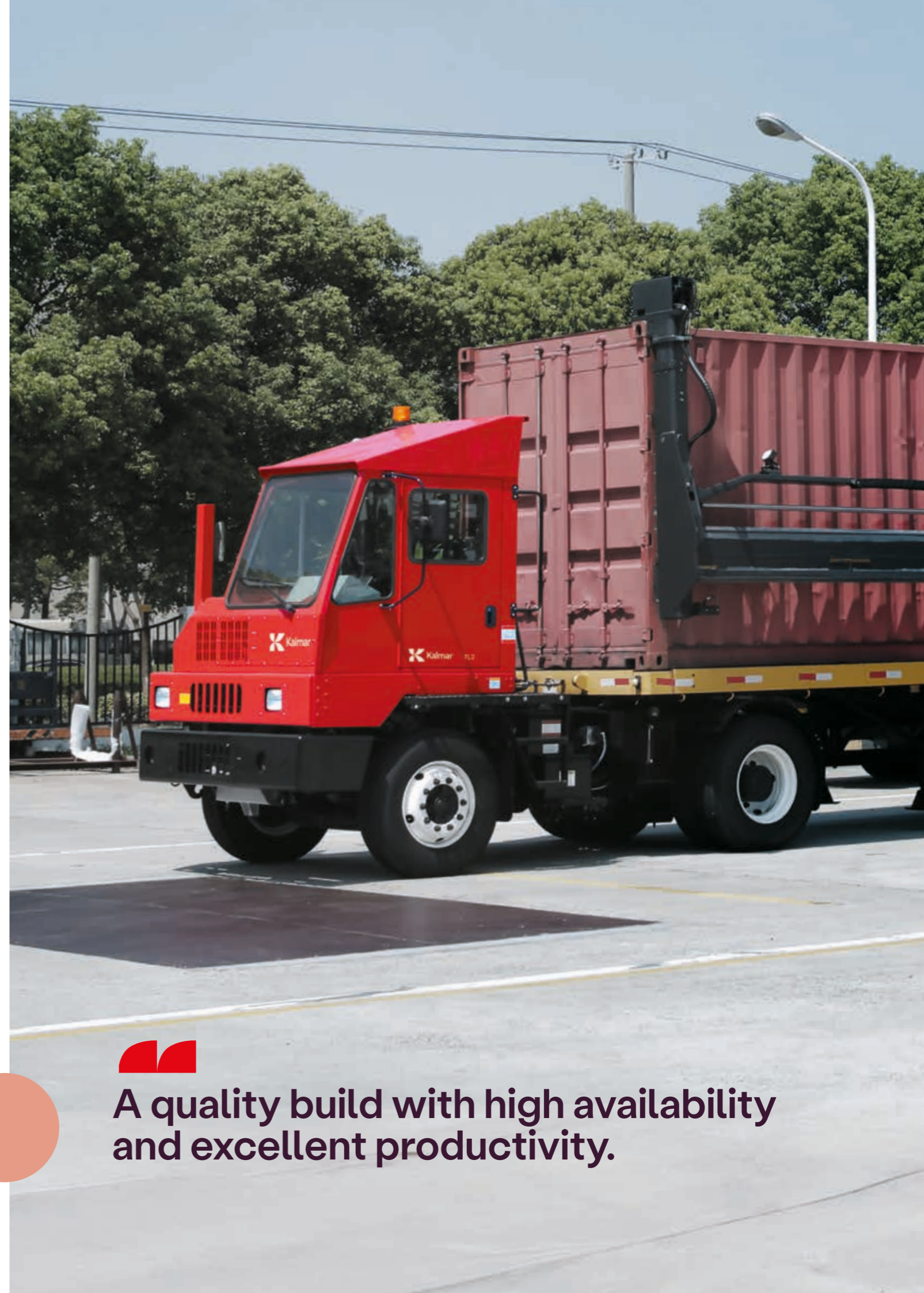

A quality build with high availability and excellent productivity.

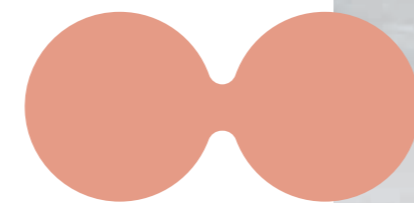
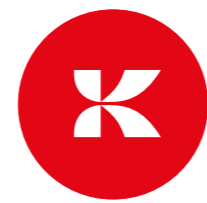
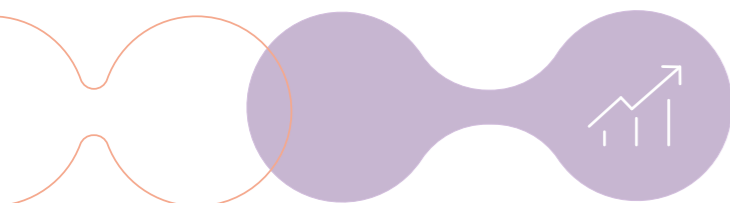

Built on a tested and proven platform



Already in operation across Asia Pacific, our Essential TL2 Terminal Tractor is built on a tested and proven platform, making it ready to take on any task.

There are many additional benefits to a tested and proven machine:

Proven chassis design: you get a highly stable and robust bolted chassis design, which is easier to maintain, repair or change than a welded chassis.

Common electrical systems: uses standardised error codes for fast and easy trouble shooting.

A standardised driver control panel: all machines have the same operator controls and interface, making it easier to move from one type of machine to another.

More options and features: you have a wider range of options and features to choose from.

More choice

You can choose to have your new Kalmar Essential Terminal Tractor delivered with either left or right hand drive to comply with local standards

You can also choose from:



Two different Cummins engines with either 129kW or 164kW rated power.



Four different front axles with capacities from 5500kg to 11250kg.



Three different fifth wheels, with 32T - 36T capacity.

Options

There are numerous options that you can choose from for your new terminal tractor, depending on your specific operational needs:



LHD or RHD cabin



Extended front bumper 6"



Front shock absorbers



Trailer stops



Fire extinguisher



Air horn



Special colors on cabin and/or chassis



LED headlights

Built to save you time and money



Reduce fuel consumption by up to 15%. Smart programming combined with our highly efficient driveline can reduce your overall fuel consumption by up to 15%. Saving you money and making your new terminal more eco-efficient as it will produce less emissions.



Less moving parts. With Kalmar Essential Terminal Tractor's hydraulics system you will have less moving parts to service and maintain over mechanical alternatives, saving you even more time.



Easier and faster to service. With an easy lift cabin and all service points accessible from the ground, servicing will be safer and quicker.



Long service intervals. With industry leading service intervals your terminal tractor will spend less time being serviced and more time operating in your yard.

Built for comfort



Climate control. With an advanced climate control system fitted, your drivers can operate safely and comfortably in temperatures from -20c to +45c.



Ergonomically designed. Our ergonomically designed cabins come with adjustable steering wheel, seat and controls so they can be set to match your driver's preferences.



Improved visibility. Our new cabin has improved visibility both forwards and to the rear platform, so your driver can operate safely at all times.



Safety built in. The TL2 features non-slip access surfaces and hand rails for easy and safe access to the cabin and rear platform.





Safety fitted as standard

For Kalmar, the safety of your drivers and maintenance staff is of critical importance, which is why our machines come with many safety features fitted as standard.

The features listed here come fitted as standard on all Kalmar TL2 Terminal Tractors. You can enhance your employees' safety further by fitting your truck with our additional safety options listed on the following pages.



2-point seat belt. Ensures that your driver is safe and secure while operating our equipment, all Kalmar machines are equipped with an adjustable 2-point seat belt system.



3-point Contact System. Makes sure your drivers are safe when entering or exiting our equipment. All machines are fitted with steps and handles to ensure they can always maintain three points of contact with the vehicle, helping to keep them safe and preventing incidental injuries.



Steps with anti-slip protection. To reduce the risk of your driver slipping or falling on our equipment, all entering and exiting points are fitted with non-slip surfaces giving them extra grip, so your drivers stay safe.



Operating information. Our equipment's Control System provides operating information, which gives your operator and maintenance personnel a great insight into the on-going performance of the machine, allowing them to keep it running optimally.



Engine/transmission Protection and Warning Systems. Warning systems, designed to protect your machine's driveline in case of higher than expected temperatures or a pressure build up, are standard on all equipment, avoiding unnecessary mechanical failures.



External reverse light. For the safety of others, all our equipment is equipped with external reversing lights that help the driver keep everyone informed that they are moving backwards.



Neutral start. Standard keypad and push button selectors automatically set to N (Neutral) when the ignition is on, preventing any damage to the driveline and any uncontrolled equipment movements.



Protection against falling objects. Cabin roof windows on all our equipment are fitted with high strength materials which can withstand heavy blows, helping to protect your drivers from falling objects.



Good visibility. Kalmar cabins provide your drivers with excellent visibility, forwards, upwards, sideways and behind them to help them stay safe while in operation.



Keep moving with Kalmar Services

To keep your business moving Kalmar Services offers a range of services that can help you keep your equipment moving optimally.

Kalmar Care

Care that keeps your business moving.

With Kalmar Care you get a flexible service that's built around your business. Including, the experience and knowledge of Kalmar's dedicated staff, coupled with transparency and increased predictability of costs.

Kalmar Care is available in three different service models: our two customisable contracts – Essential Care and Complete Care – and our flexible solution On Demand Care.

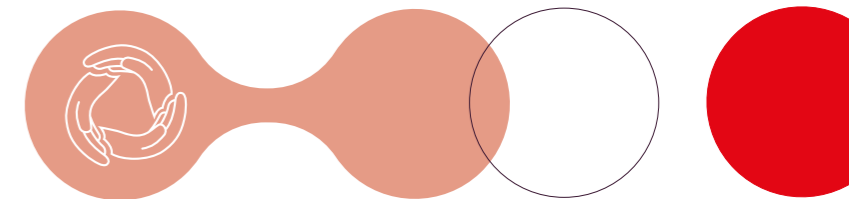

Service models:



Essential Care

A maintenance solution to keep your equipment in an optimal condition.



Complete Care

A complete service solution providing piece of mind and maximum equipment uptime.



On Demand Care

Top-of-the-line service whenever you need it.

Maintenance Planning	●	●
Preventive Maintenance	●	●
Predictive Maintenance		●
Corrective Maintenance		●
Preventive Spare Parts	●	●
Corrective Spare Parts		●
Lubricants	●	●
MyKalmar	●	●
Kalmar Insight	●	●
Tyre Maintenance		●
Battery Maintenance		●

● Included ● Optional

Top-of-the-line service
whenever you need it

MyKalmar

Keeping your cargo moving.

The MyKalmar portal brings together many of Kalmar's digital services into one place. With a single point of access and a user-friendly design you'll benefit from greater visibility and control over your maintenance activities, parts ordering and equipment performance - helping you improve your operational performance, safety and efficiency across your entire fleet.

MyKalmar STORE

MyKalmar STORE is your one stop shop for all the parts you need which is accessible through MyKalmar. Open 24/7, accessible on any screen and available in different languages, our store stocks 100s of thousands of Kalmar Genuine Parts at any given time and we can have them delivered quickly to you, no matter where you are in the world. You can search, order and then track your order all through the same application. MyKalmar has been designed to make your life easier.

Kalmar Insight

Optimise your operations with Insight.

Kalmar Insight* is a performance management tool for cargo handling, which gives you an easy to use overview of your fleet operations, by aggregating data from multiple sources, including equipment built by other manufacturers. Review your entire fleet activities, schedule maintenance activities and order

the required parts automatically. All enabling you to take action on real-time information, that will help improve your overall operations immediately. Kalmar Insight comes fitted and ready to be activated in all new Kalmar equipment, it can also be retrofitted into existing Kalmar equipment or those built by other manufacturers.



*Installation costs and/or an annual subscription fee may apply.

Kalmar Training

Enhance your skills.

To get the most out of your new machine our training centre offers a range of courses for both your technicians and operators. Operators can be taught how to drive the machine for optimum performance and minimum waste, and to learn what needs to be checked daily for optimal safety. Technicians can be educated with the knowledge they need to keep your new equipment in top condition in a safe way. Courses are a mix of theory and hands-on experience.



Technical information*

Wheelbase	Overall Length	Trailer clearance		
		Fixed fifth wheel	Boom up	Boom down
2946 mm	4760 mm	2117 mm	2020 mm	2123 mm
3200 mm	4900 mm	2371mm	2273 mm	2377 mm

Tyre size	Down Height		Cab Height	Ground Clearance
	Rigid Axle	Air suspension W/lowering		
11R22.5	1260 mm	N/A	3211 mm	170 mm
280/75R22.5	1194 mm	N/A	3190 mm	149 mm

Transmission	Load Carrying devices	Lift height	Capacity
Allison 3000 series	Stationary 5th wheel	N/A	
Allison 3500 series	Port package	430mm	28t

Powertrains	Rated kW @ rpm	Rated torque @ rpm
Standard - Cummins QSB6.7 220 HP / 164kW Tier 3 / EU Stage 3A	164 kW @ 2200 rpm	949 Nm @1500 rpm
Option - Cummins QSB6.7 173 HP / 129kW Tier 3 / EU Stage 3A	129 kW @ 2200 rpm	800 Nm @1400 rpm

Front axle options	Capacity @ speed	Hub
Hande front axle 5.5t with 400x150 Brakes, 335 mm with Automatic Slack Adjusters	5500 KG @ 25 km/h	335mm
Hande front axle 7.5t with 410x160 Brakes, 335 mm and Automatic Slack Adjusters	7500 KG @ 25 km/h	335mm
Kalmar FA 11 front axle 11.25t with 410x160 Brakes, 335mm and Automatic Slack Adjusters	11250 KG @ 20 km/h	335mm

Rear axle options	Ratio	Capacity @ speed
Hande with 11.98 ratio 32000 KG @ 25 km/h with Automatic or Manual Slack Adjusters	11.98	32000 KG @ 25 km/h
Kalmar RA38 rear axle 38000 KG @ 25 km/h and Automatic Slack Adjusters	12.20 14.60	38000 KG @ 20 km/h

Fifth wheels	Capacity
Holland FW35TT	36000 KG
Holland FW0E70	32000 KG
Holland FW FW3510	36000 KG

* Information is subject to change.

The Kalmar Essential Terminal Tractor

Built to meet your requirements, the Kalmar Essential Terminal Tractor will exceed your expectations

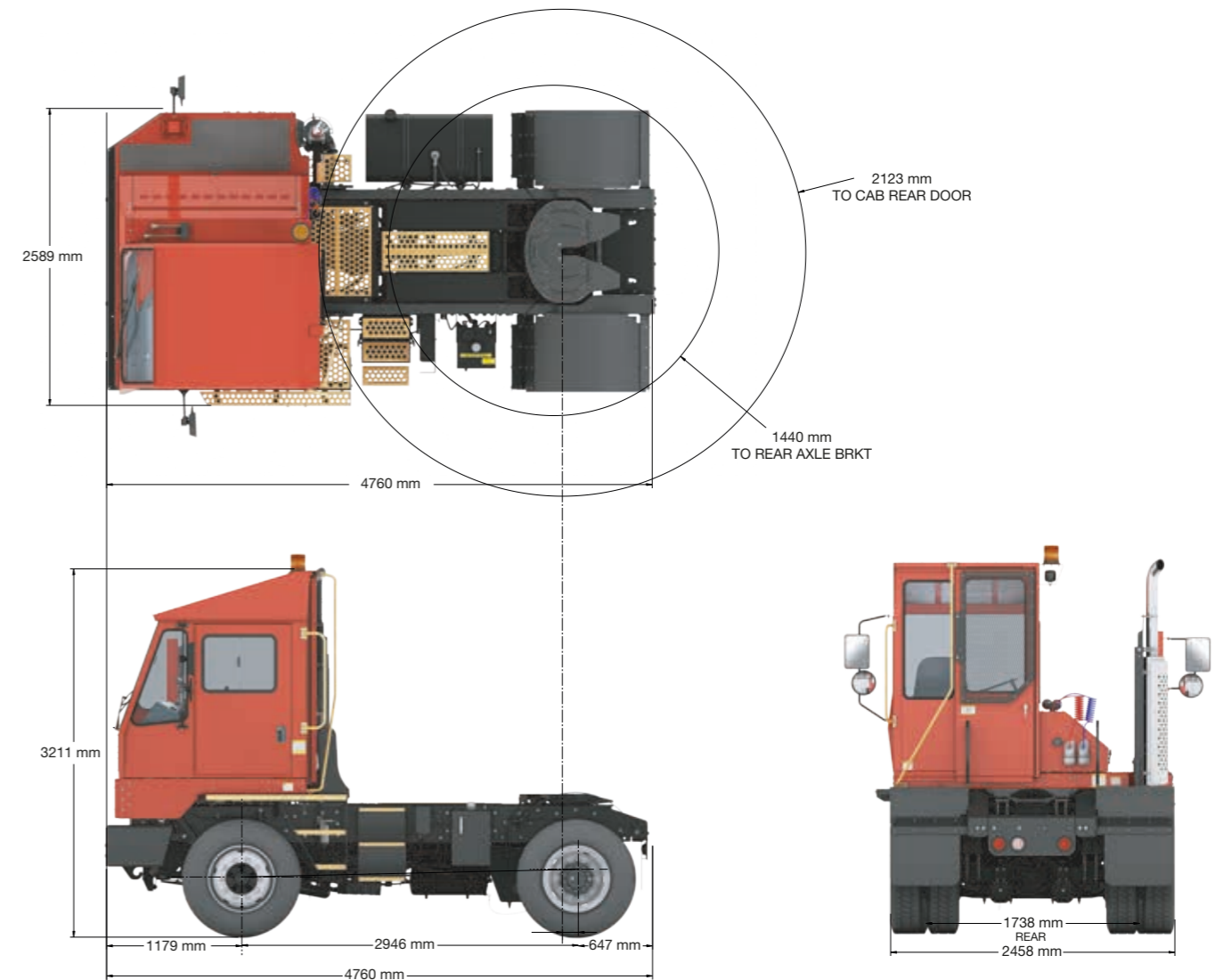



Kalmar

www.kalmarglobal.com

Published by Kalmar, Copyright © Kalmar Corporation 2024.
All rights reserved.

2024-08-27

